

# PROPRIETES THERMIQUES ET ELECTRIQUES DES NANO ET MICROCOMPOSITES

Abderrahim BOUDENNE

Université Paris-Est Créteil (UPEC)/CERTES  
France

# Composites polymères/charges conductrices

## Charges conductrices

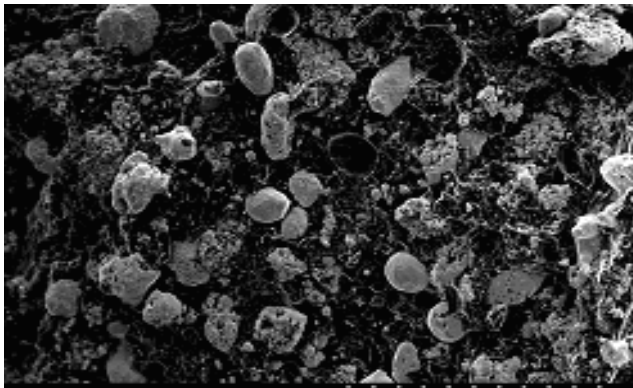

PP/Cu

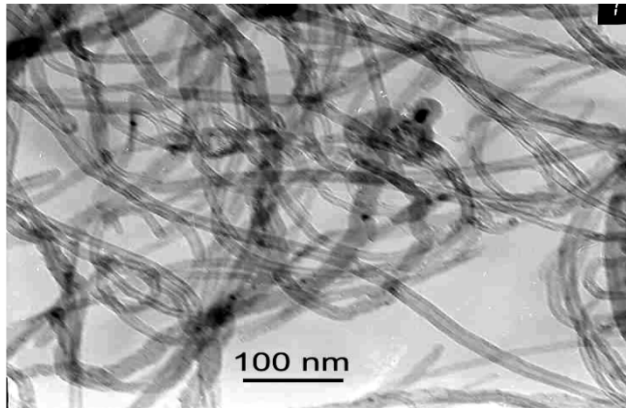

PVC/MWCNT

## Charges isolantes métallisées

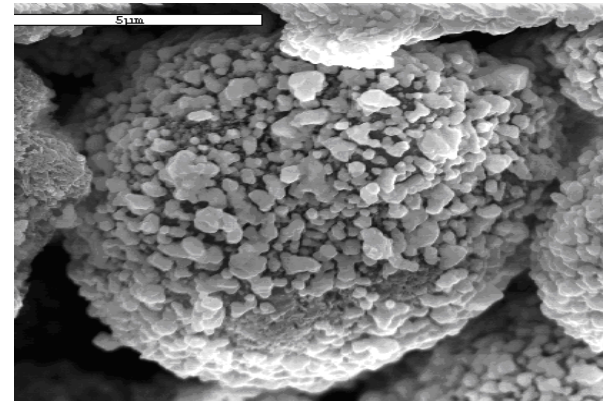

EVA/Wollastonite-Ag

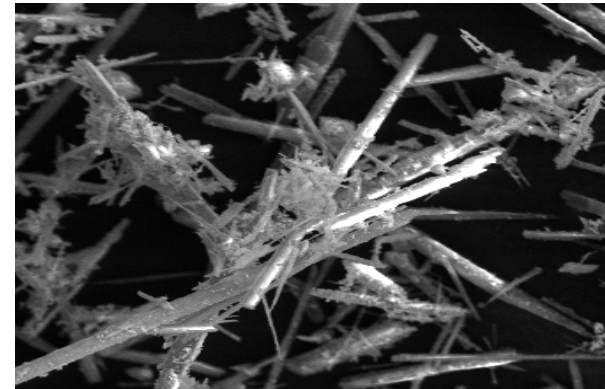

HDPE/PA-Ag

# Composites polymères/charges conductrices

## Modélisation $\lambda$ de la charge

### EVA/Wollastonite-Ag

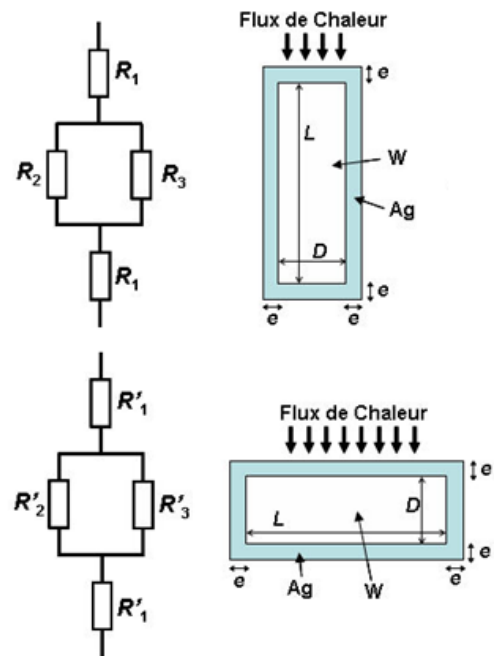
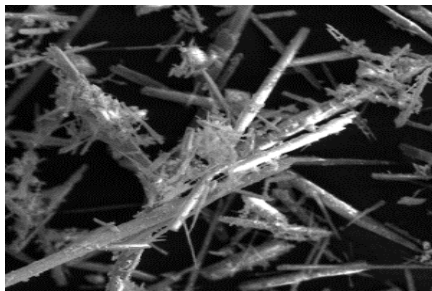

### HDPE/PA-Ag

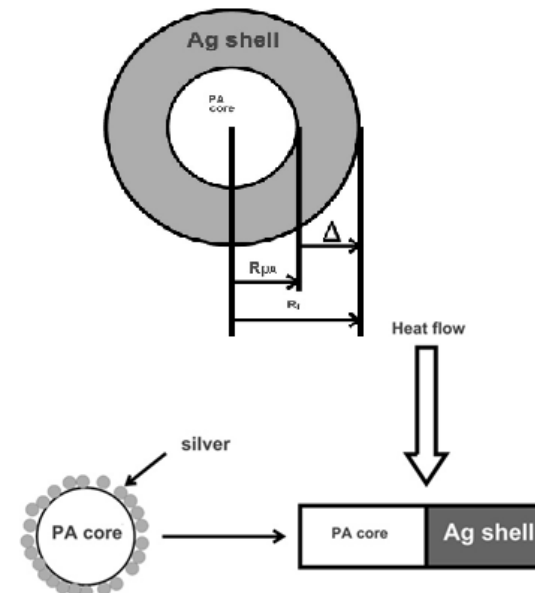
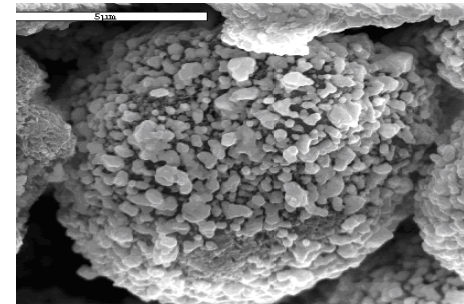

# Composites polymères/charges conductrices

## Modélisation $\lambda$ des composites

### Modèles numériques

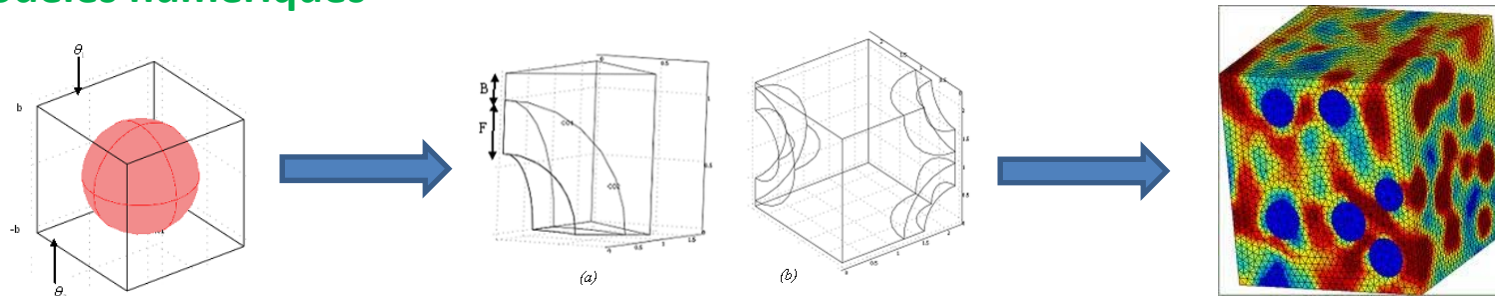

### Effet de la concentration en charges

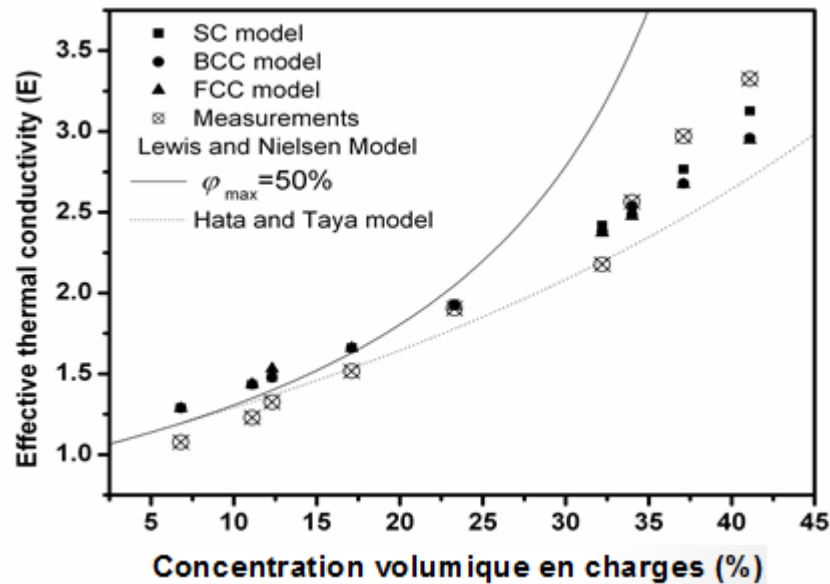

### Effet de la résistance de contact

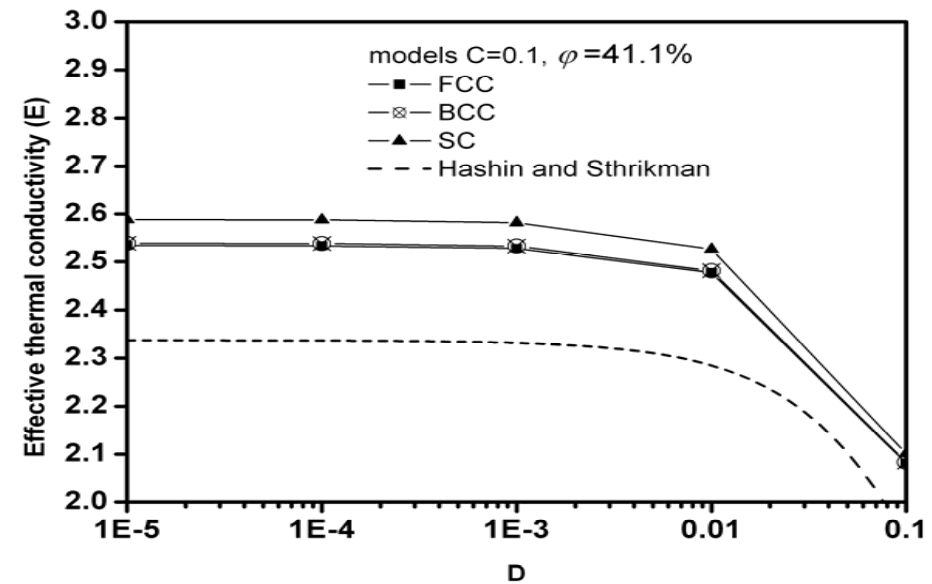

# Biocomposites et matériaux à base de fibres naturelles

## Composites à matrices polymères/fibres naturelles

Fibres: Ananas, Banane, Sisal, ...



# Biocomposites et matériaux à base de fibres naturelles

## Composites à matrices minérales/fibres naturelles

### FPD: Fibres de Palmier Dattier

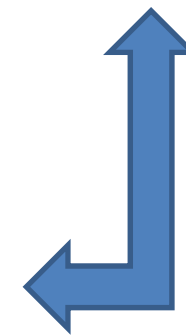
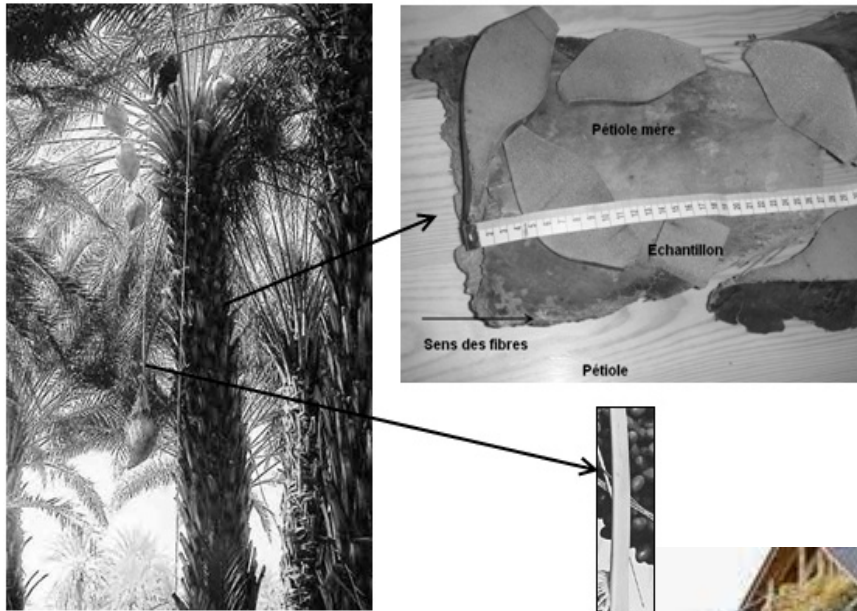

# Optimisation des propriétés thermophysiques et électriques des composites à matrice polymère par application d'un champ magnétique

Abderrahim BOUDENNE

Université Paris-Est Créteil (UPEC)/CERTES  
France

**Polymers are materials with low value of thermal conductivity**

  $0.15 \leq k \leq 0.5 \text{ [Wm}^{-1}\text{K}^{-1}\text{]}$

**Increase thermal properties for industrial applications**



**Combine polymeric matrix with conductive fillers**

**Develop new materials with properties adapted to specific applications**



# Polymer Composites with conductive fillers: Bibliographic Statistics

Source: Web of Knowledge (Thomson Reuters 2014)

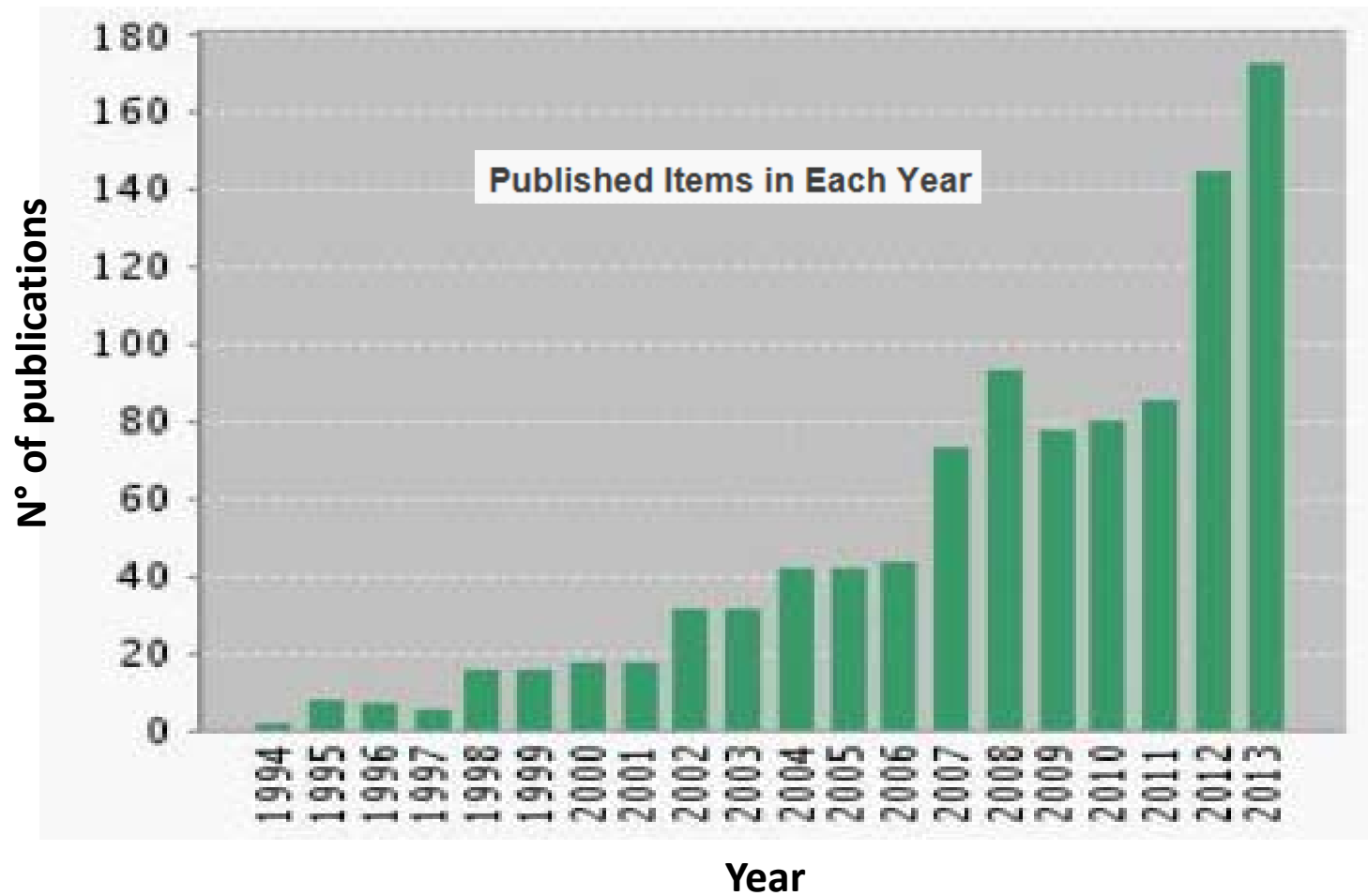

## Aims

**How optimize the conductive properties of polymer composite materials?**



**Use an electric and magnetic field during the preparation of the composites**

# Samples preparation

Matrix: Silicone Rubber

Fillers: Ni ( $10\mu\text{m}$ )

From 0 to 35% vol. Ni  $\rightarrow$  in Silicone Rubber Matrix

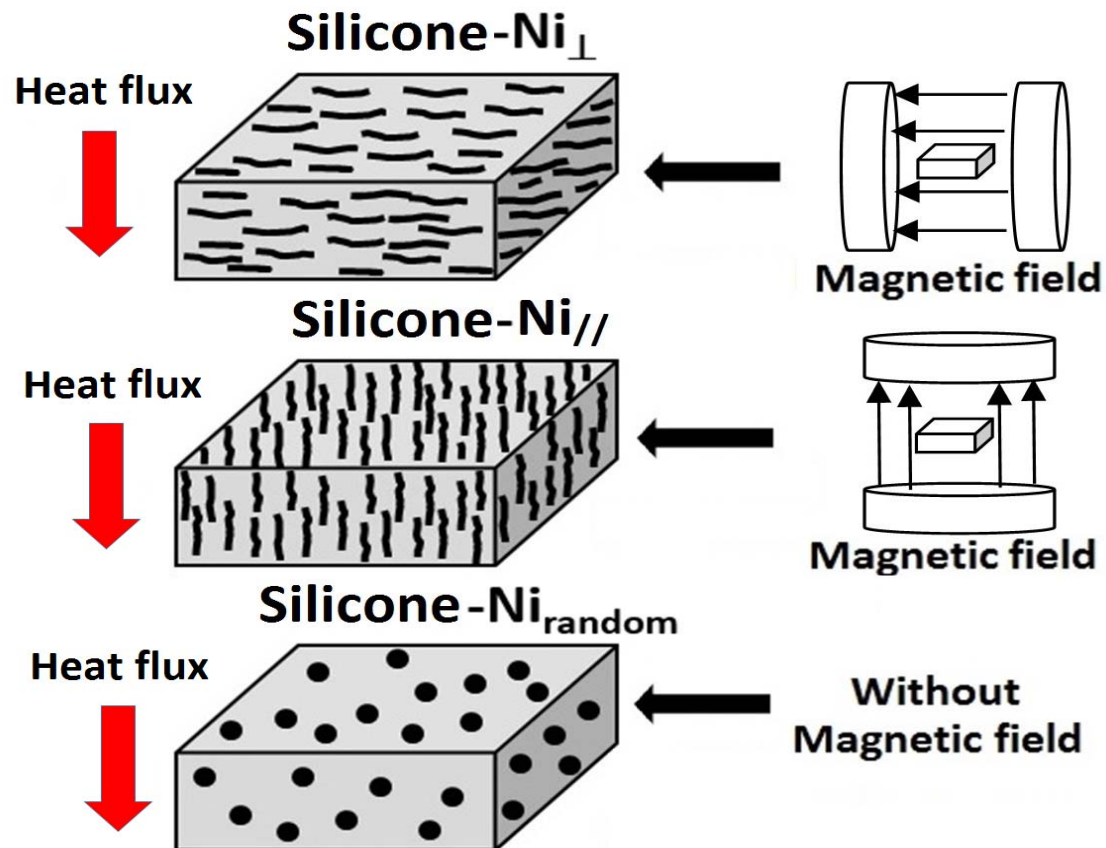

# Micrograph structure

Matrix: Silicone Rubber

Fillers: Ni ( $10\mu\text{m}$ )

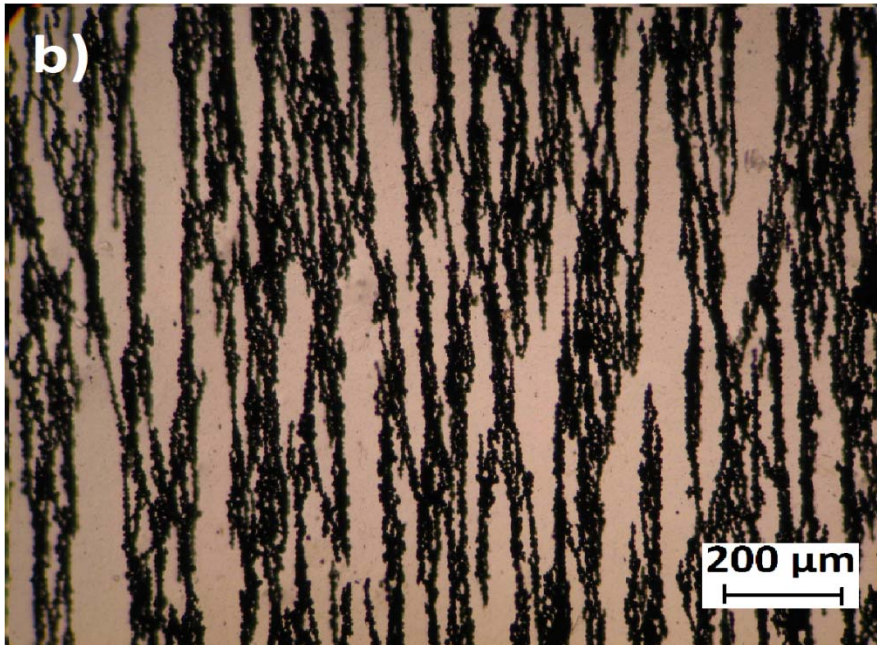

**With magnetic field**

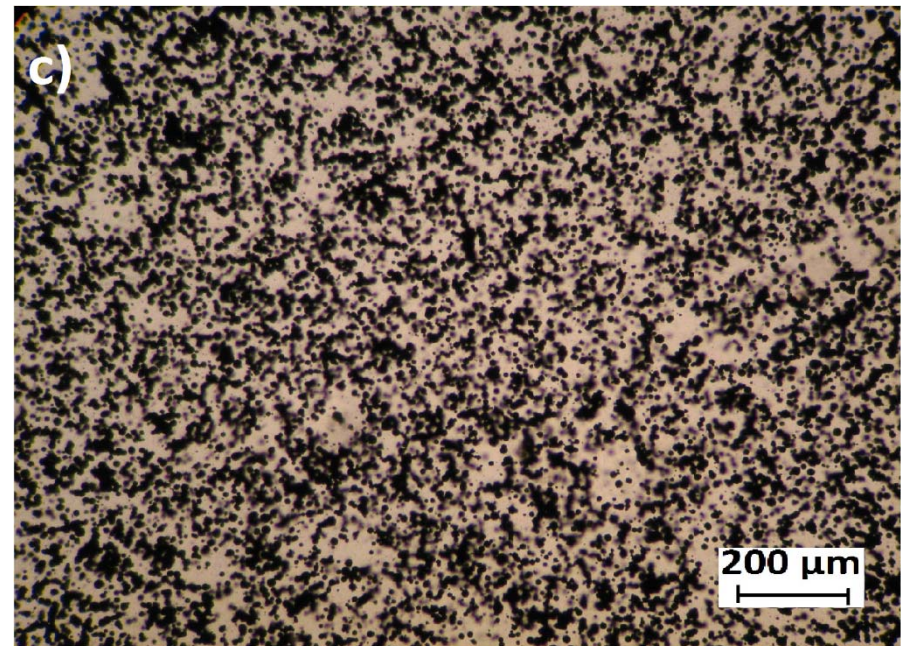

**Without magnetic field**

# Thermophysical behavior

## Specific heat capacity

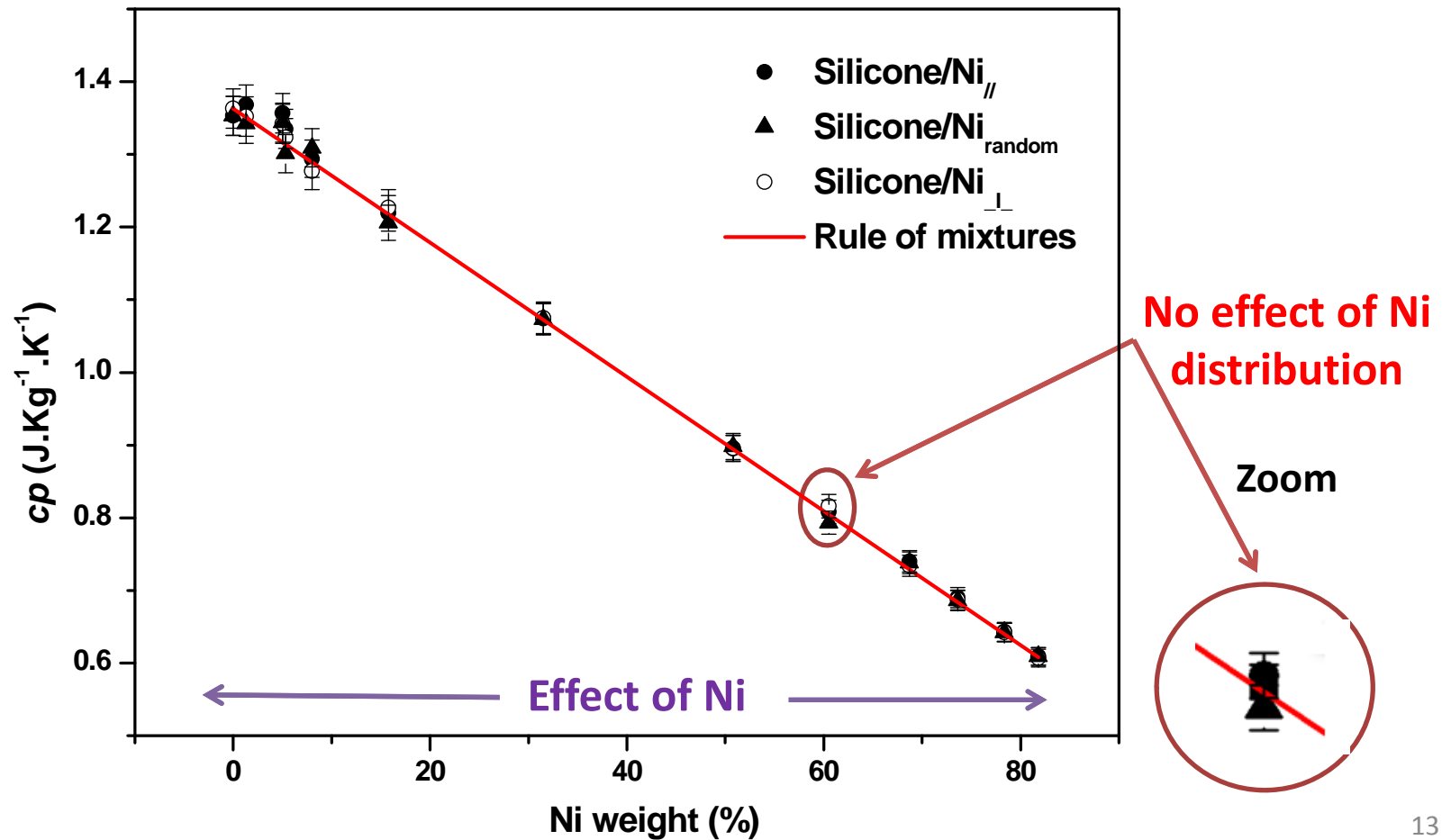

# Thermophysical behavior

## Thermal Conductivity

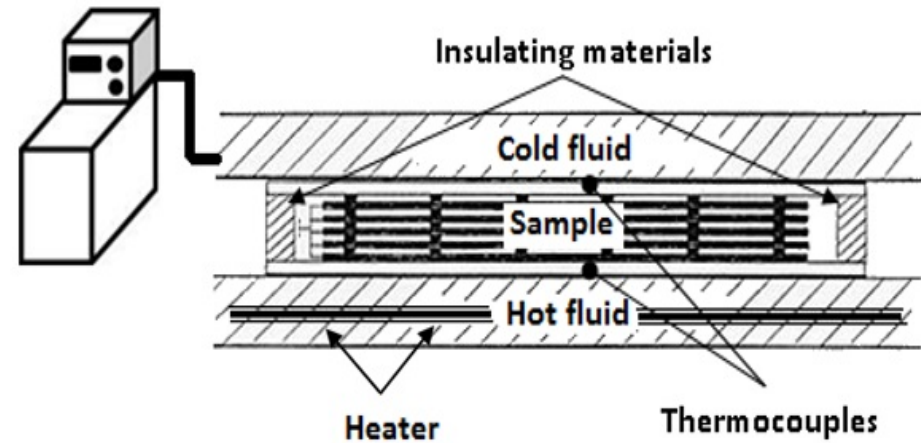
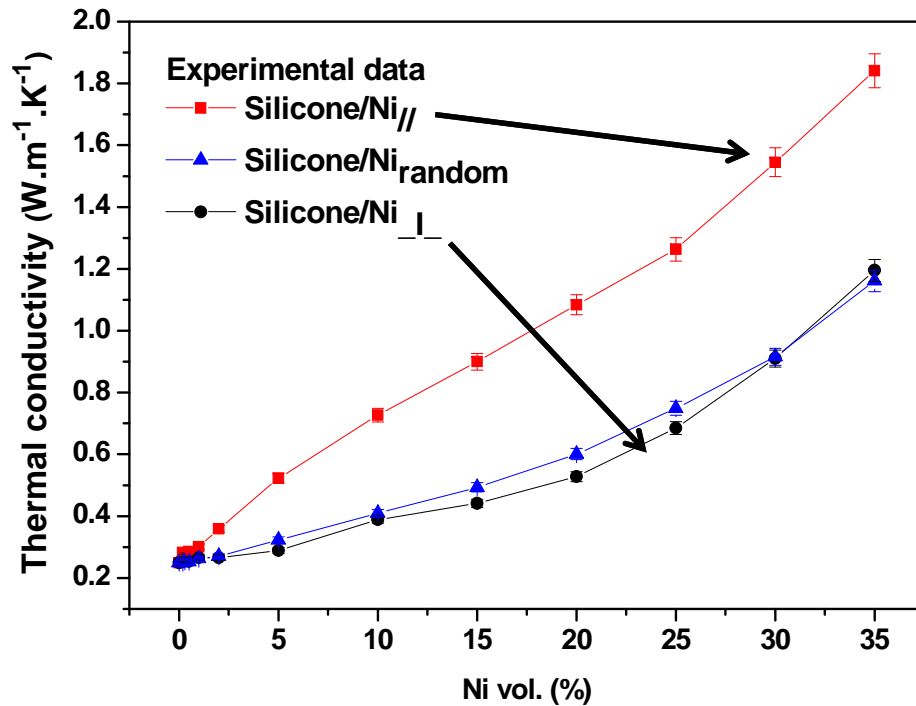

Thermal conductivity experimental setup based on (HGP) method

# Thermophysical behavior

## Thermal Conductivity

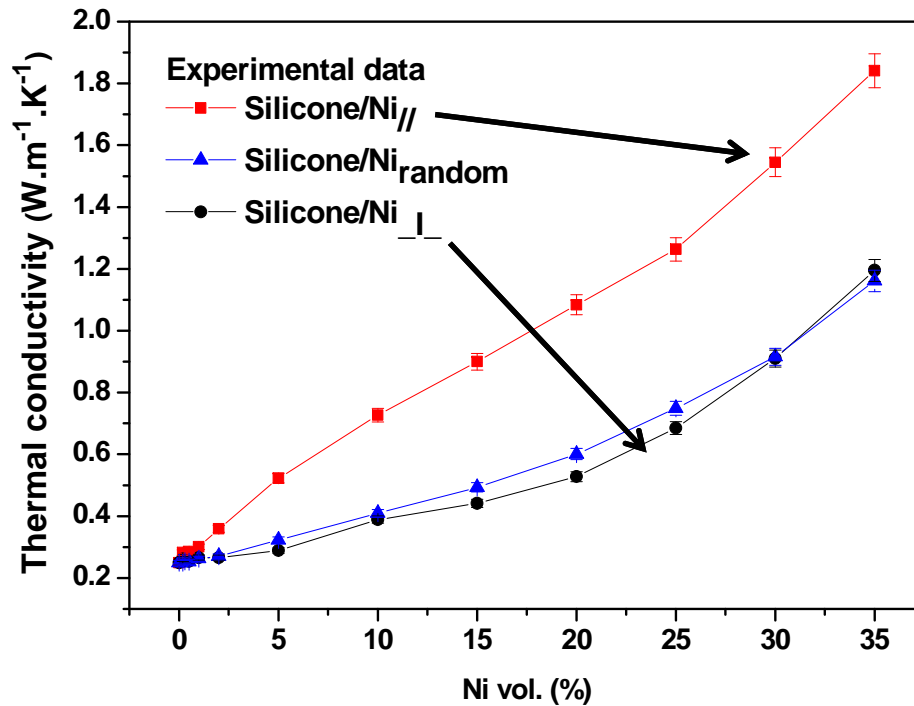

## Thermal diffusivity

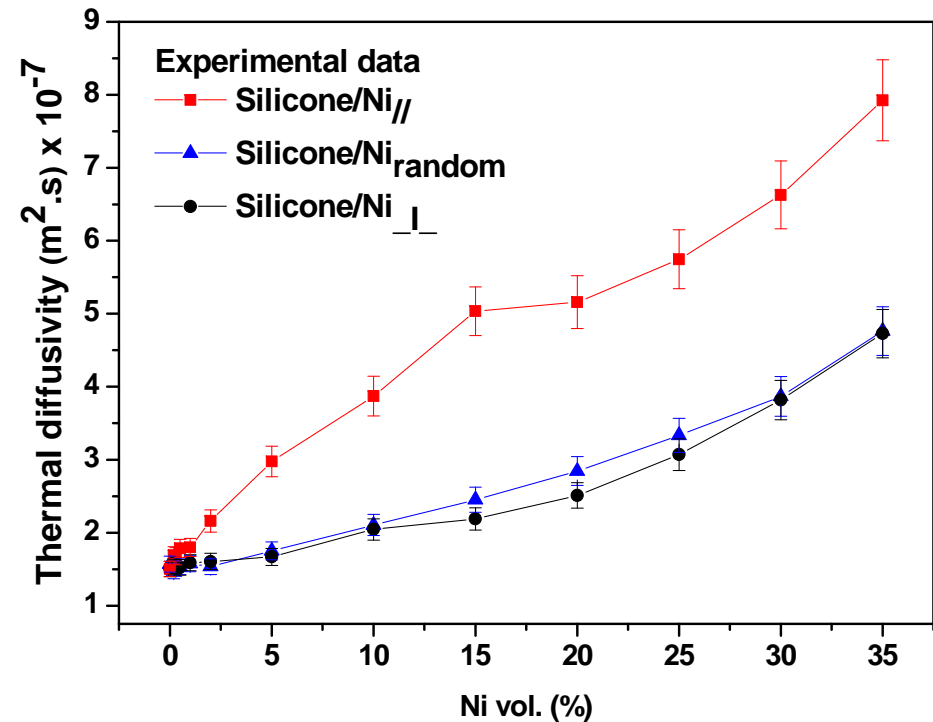

□ Effect of Ni vol. (%)

□ Effect of Ni distribution

□ Same behavior (thermal conductivity and diffusivity)

# Thermophysical behavior

## Thermal Conductivity

Low Ni vol. → Poor chain-like structure without magnetic field



High spatial anisotropy

High Ni vol. → Spatial distribution of Ni tends to be almost the same



Less effect of magnetic field

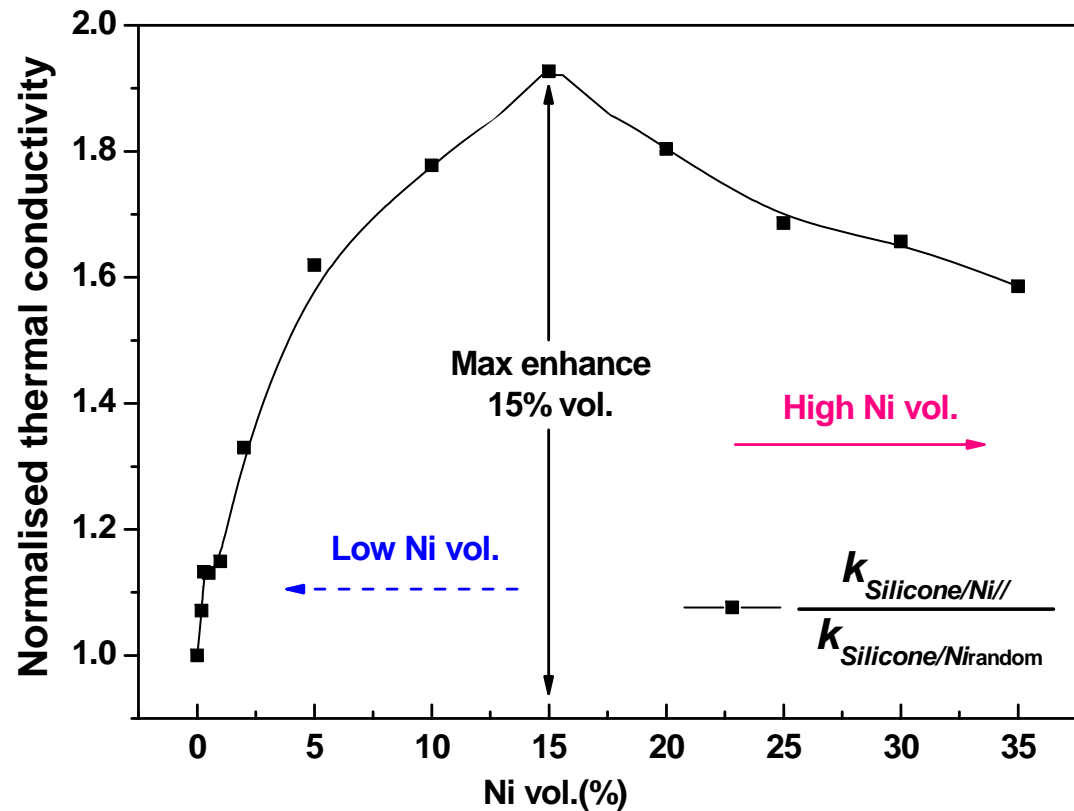



# Thermophysical behavior

## Thermal Conductivity models

Lichtenecker's model



Agreement with measured values  
( $\perp$ , random) until 10 % vol.

$Ni_{//} > 25\% \text{vol.}$



experimental values approximate  
Lichtenecker's model

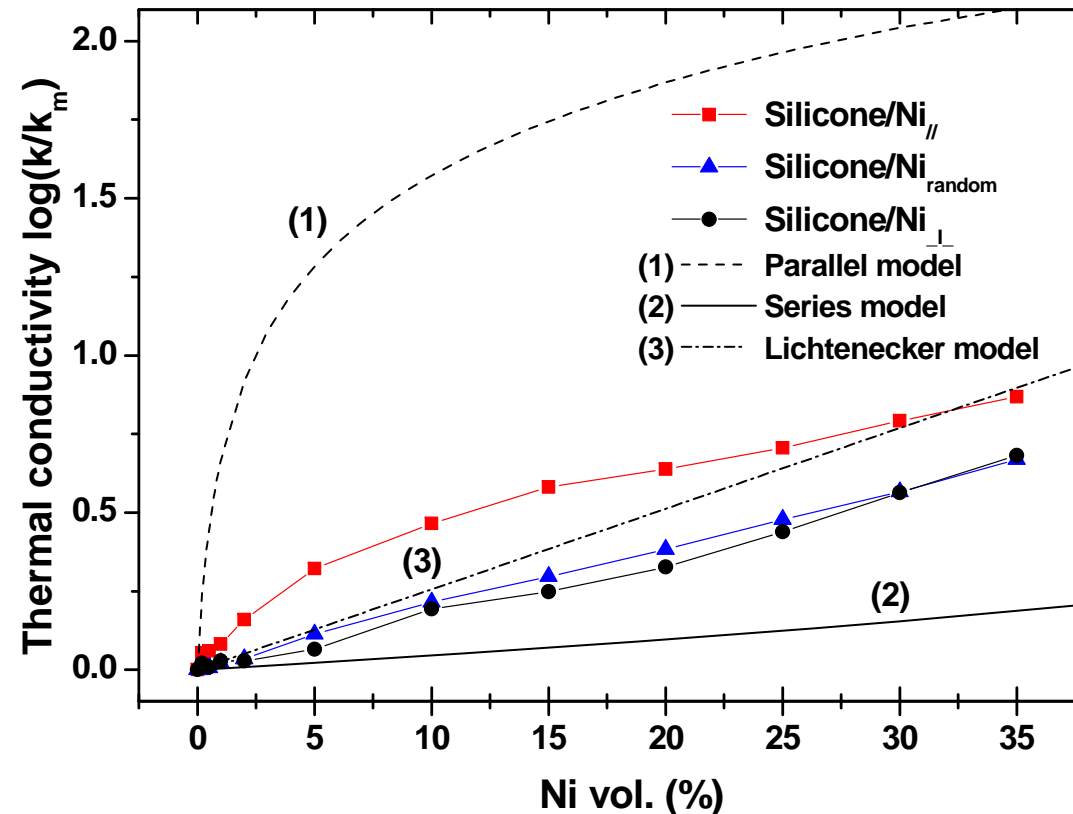

- ❖ Structure effect with gradual reduction of  $\lambda$  when Ni increase

# Electrical behavior

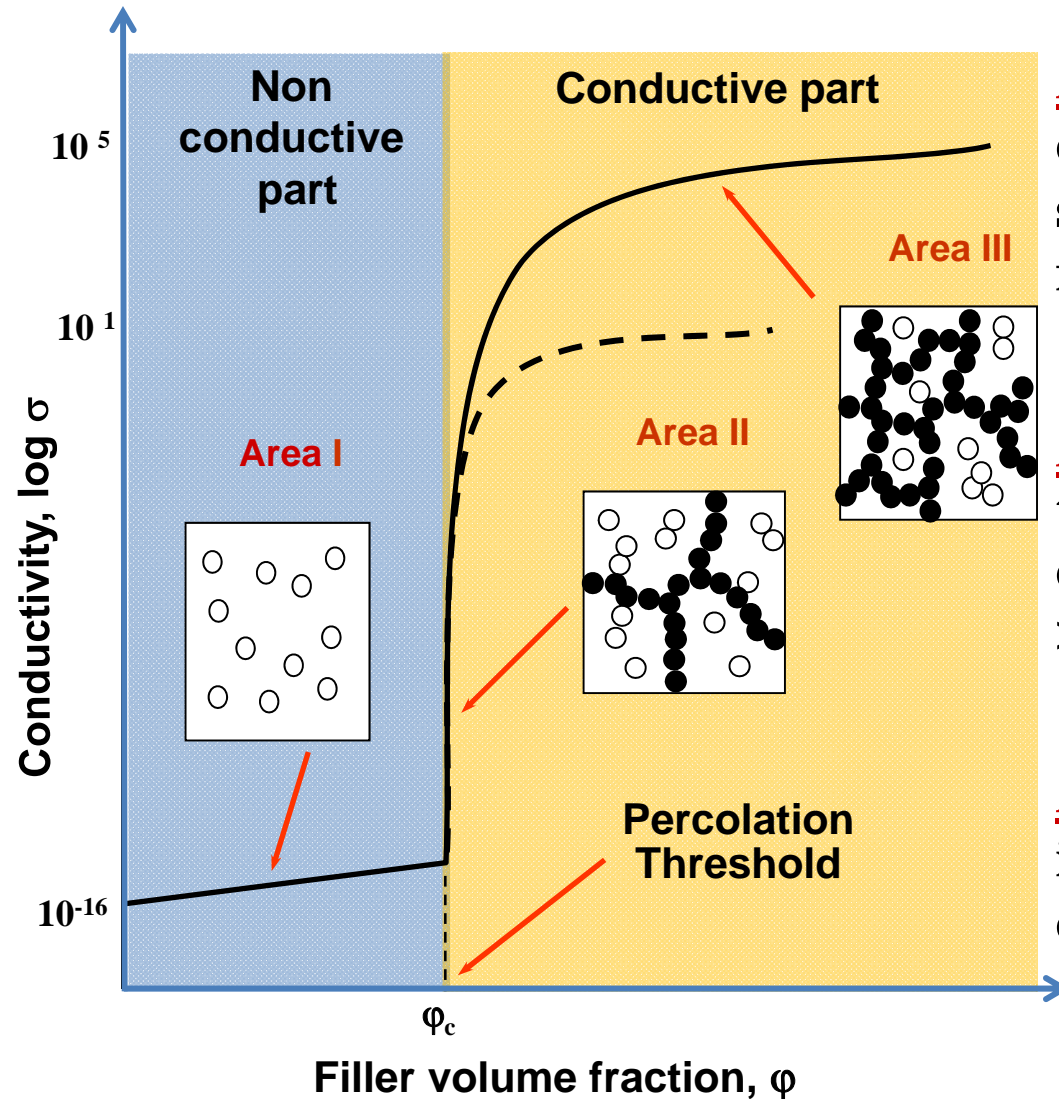

**Area I** – the composite is non-conductive, the matrix includes the separate particles of conductive filler.

**Area II** – the region of percolation, the conductive cluster is created, the conductivity sharply increases at  $\varphi > \varphi_c$ .

**Area III** – the conductivity slowly increases because of growth of conductive cluster.

# Electrical behavior

## Electrical Conductivity

□ Effect of Ni

□ Effect of Ni distribution

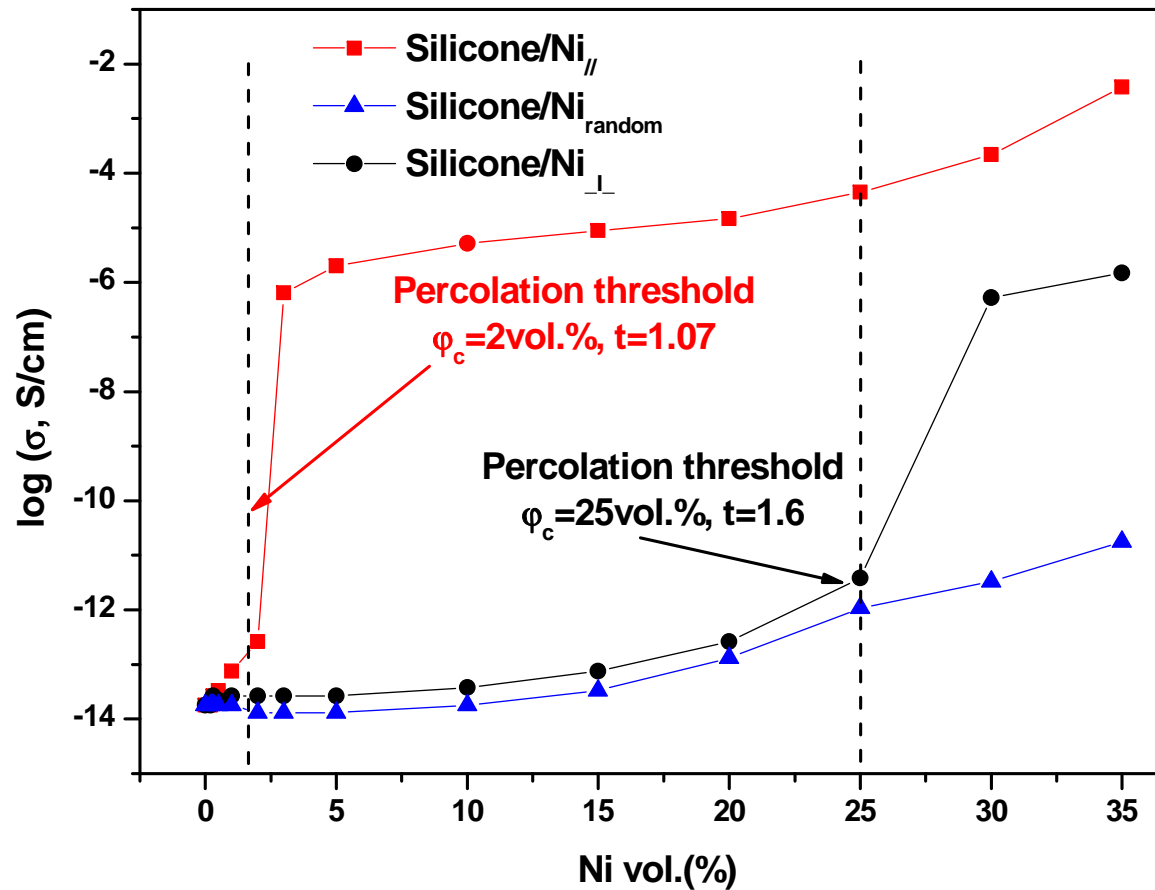

# Conclusion

- Combination of polymers with conductive fillers allows an increasing of both thermal and electrical properties
- Effect of Ni content on  $\lambda$ ,  $\alpha$ , cp and  $\sigma$
- Effect of Ni distribution (orientation) on  $\lambda$ ,  $\alpha$ , and  $\sigma$
- Use of a magnetic field during the preparation of the composites → enhancement of the conductivities ( $\lambda$ ,  $\sigma$ ) and  $\alpha$

**Thank you**